

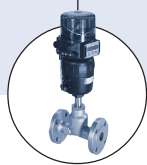

- Electropneumatic positioner for pneumatically actuated control valves

Type 8630 can be combined with...



**Type 2712**

Piston-controlled globe valve



**Type 2702**

Piston-controlled angle seat valve

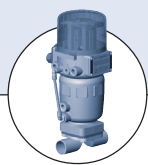

**Types 2730/2731/2731K**

Piston-controlled diaphragm valve

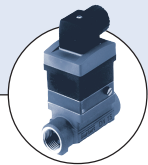

**Type 8030**

In-line flow sensor

The TopControl Continuous Type 8630 works as an electropneumatic positioner for pneumatically actuated control valves with piston actuators, e.g. the series 2702, 2712, 2730, 2731 and 2731K, as well as ball and butterfly valves with pneumatic rotary actuators. Together with the pneumatic actuator, it forms an optical and functional unit. With its numerous software functions, TopControl Continuous Type 8630 may also be used as a process controller with PID characteristics. In this case a process control loop is superposed upon the positioner loop in a cascade structure. The process value is led directly to the TopControl as a standard current signal, frequency or PT-100 signal. The control system may be used for a variety of control tasks in fluid technology.

Main functional groups:

- Position sensor for continuous measurement of the current position in the pneumatic actuator,
- Microprocessor controlled electronics for signal processing, actual/setpoint comparison, control and valve drive,
- Pneumatic positioning system for single or double acting actuators.

Technical Data	
<b>Housing material</b>	PPE/PA
<b>Cover material</b>	PSU (transparent)
<b>Seal material</b>	NBR
<b>Control medium</b>	Quality classes to DIN ISO 8573-1
<b>Dust content</b>	Class 5 ( $\leq 40 \mu\text{m}$ particle size)
<b>Particle density</b>	Class 5 ( $\leq 10 \text{ mg/m}^3$ )
<b>Pressure dew point</b>	Class 3 ( $\leq -20 \text{ }^\circ\text{C}$ )
<b>Oil concentration</b>	Class 5 ( $\leq 25 \text{ mg/m}^3$ )
<b>Control air temperature</b>	-10 ... +50 °C
<b>Ambient temperature</b>	-10 ... +50 °C
<b>Positioning system</b>	For pressurizing and/or exhausting the pneumatic piston actuator
<b>single acting actuator</b>	2 solenoid valves
<b>double acting actuator</b>	4 solenoid valves
<b>Control air sockets</b>	G 1/4 NPT 1/4; RC 1/4 on request
<b>Supply pressure</b>	3 ... 7 bar <sup>1)</sup>
<b>Flow capacity <math>Q_{Nn}</math> (of control valve)</b>	100 l/min (for pressurizing and exhausting)
<b>Intrinsic air consumption</b>	0 l/min
<b>Position sensing system</b>	High resolution conductive plastic potentiometer, coupled without play to the piston rod of the actuator.
<b>Operating voltage</b>	24 V DC $\pm 10\%$
<b>Residual ripple</b>	10 %, Not industrial DC!
<b>Power consumption</b>	< 5 W
<b>Electrical connection</b>	3 bushings (M16x1.5 with screw terminals) circular multipole plug
<b>Setpoint setting</b>	0/4 ... 20 mA, 0 ... 5/10 V
<b>Input resistance for setpoint signal</b>	180 $\Omega$ with 0/4 ... 20 mA 19 k $\Omega$ with 0 ... 5/10 V
<b>Sensor inputs for process controller</b>	4 ... 20 mA Pt 100, frequency
<b>Input resistance for process value signal</b>	180 $\Omega$ with 4 ... 20 mA 17 k $\Omega$ with frequency

<sup>1)</sup> The supply pressure applied must be at least 0.5 ... 1 bar above the max. permissible control pressure of the valve actuator.

Technical data (continued)

Technical Data	
Options	2 binary outputs, inductive proximity switches, analog feedback, process controller
Bus communication	PROFIBUS DP or DeviceNet others on request
Operating panel and configuration	Module with 3 keys for parametrization
Display for setpoint and process value	8-digit, 16-segment LC display
Type of protection	IP 65 to EN 60529
Protection class	3 to VDE 0580
Conformity	CE to EMV-9/336/EEC

- Flow capacity value for air [l/min] measured at +20 °C, 6 bar<sup>1)</sup> pressure at valve input and 1 bar pressure difference

<sup>1)</sup> Pressure stated in [bar]: are excess to atmospheric

Dimensions [mm]

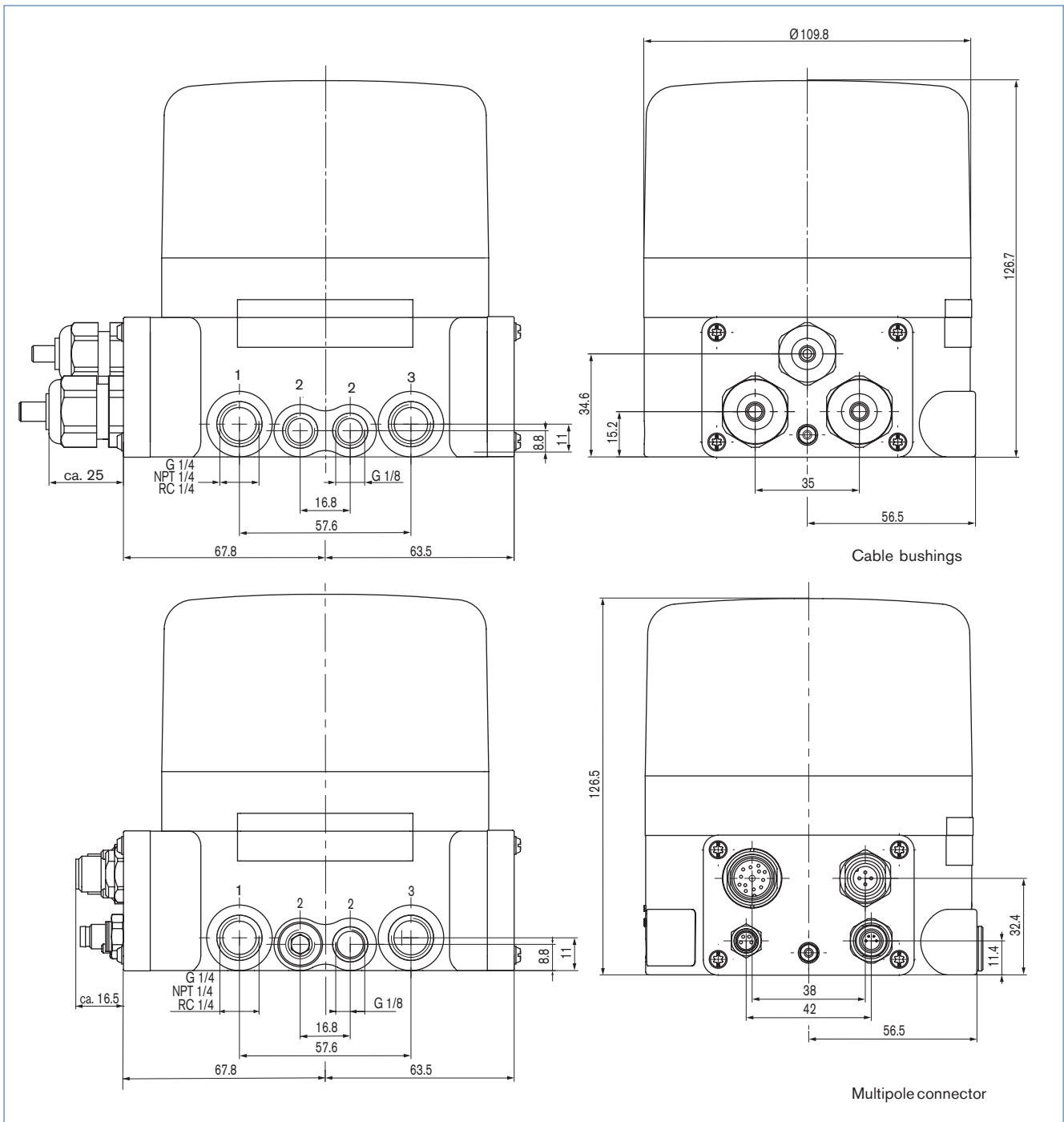

DTS 1000010797 EN Version: C Status: RL (released | freigegeben | validé) printed: 30.06.2006

**Schematic representation of TopControl Continuous (3-conductor-device)**

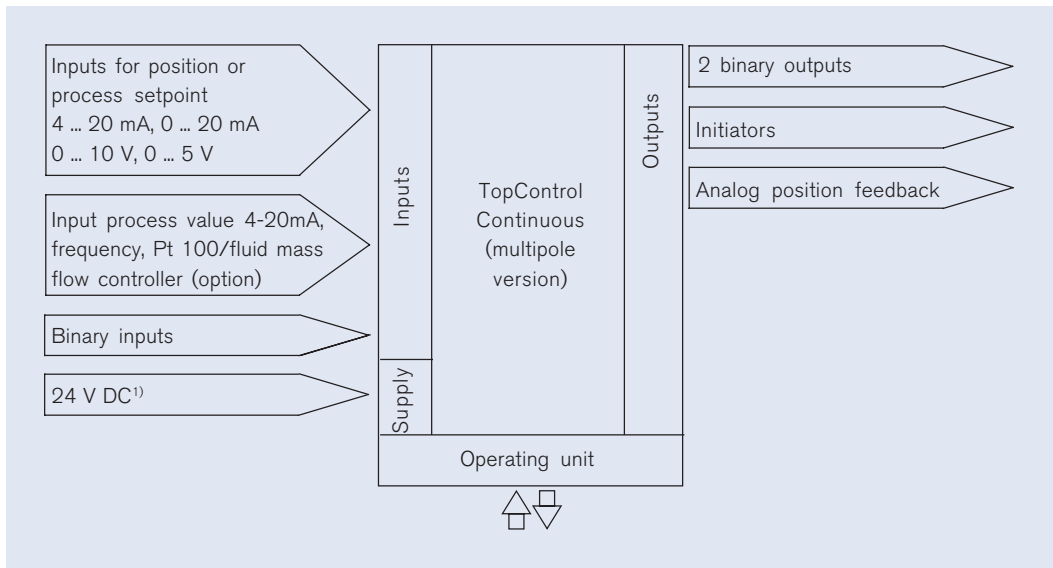

<sup>1)</sup> With a 3-conductor device the operating voltage is supplied independent of the setpoint signal.

**Signal flow plans**

**Position control loop**

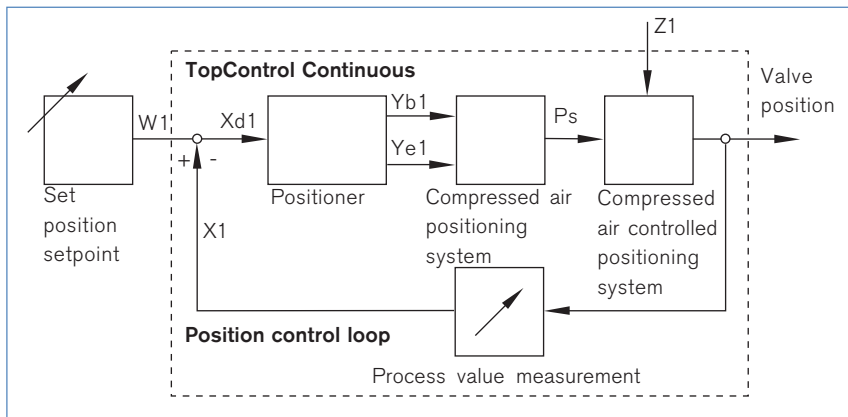

**Process control loop**

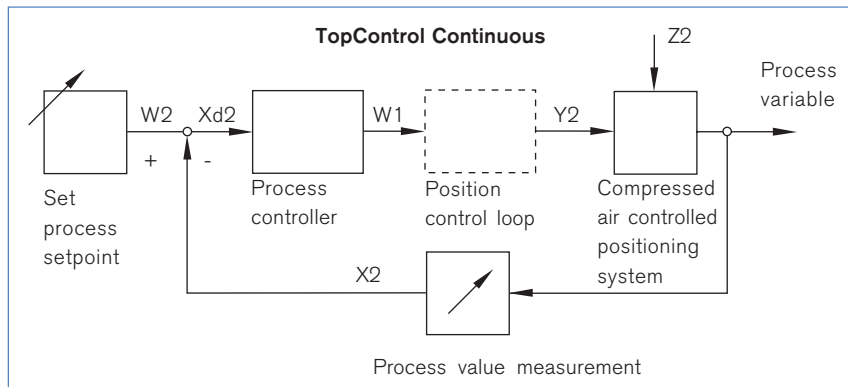

Supplementary software functions in TopControl Continuous

- Automatic commissioning of the control system
- Automatic parametrization of the optional integral process controller
- Automatic or manual selection of characteristic curve
- Parametrization of the positioner
- Parametrization of the process controller
- Configuration of one binary input
- Configuration of one analog or two binary outputs
- Setting of a setpoint range
- Limitation of stroke range
- Setting of a tight closure or max. stroke threshold
- Setting of direction of motion
- Code protection

DTS 1000010797 EN Version: C Status: RL (released | freigegeben | validé) printed: 30.06.2006

Connection options

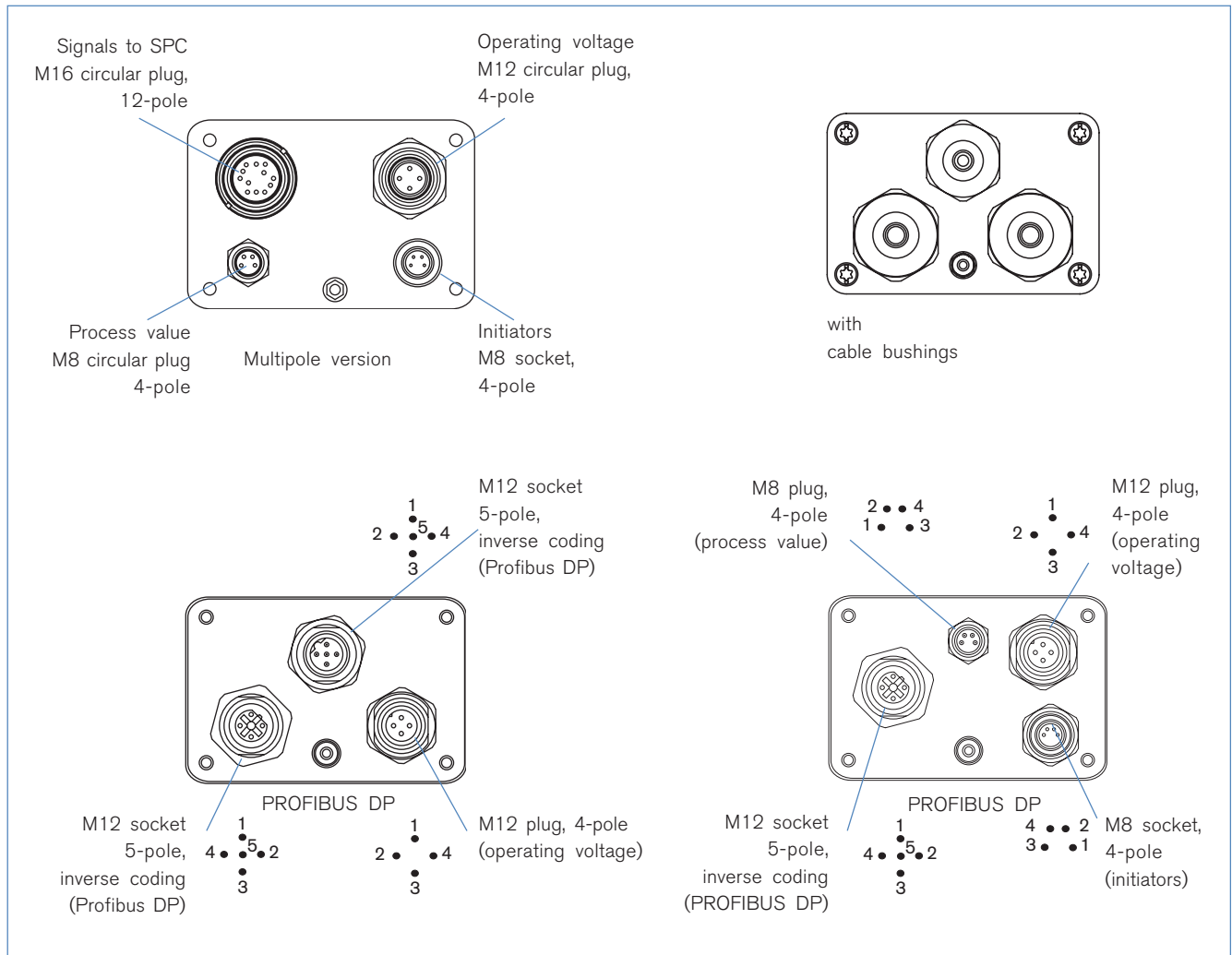

Ordering information for complete control valves

A **complete control valve** consists of a **TopControl Continuous Type 8630** and a **control valve Type 27xx**. TopControl Continuous Type 8630 is supplied only with a positioning valve as part of a complete control valve. For the selection of a complete control valve, the following data are required:

- Order no. of the TopControl Continuous (see *Ordering Table for TopControl Continuous Type 8630 without positioning valve*)
- Order no. of the chosen positioning valve Type 27xx (see e. g. *Ordering Tables for Types 2702, 2712, 2731K*)
- The remark: TopControl Control Valve System

DTS 1000010797 EN Version: C Status: RL (released | freigegeben | validé) printed: 30.06.2006

Ordering of complete control valves, using globe valve Type 2712 as an example

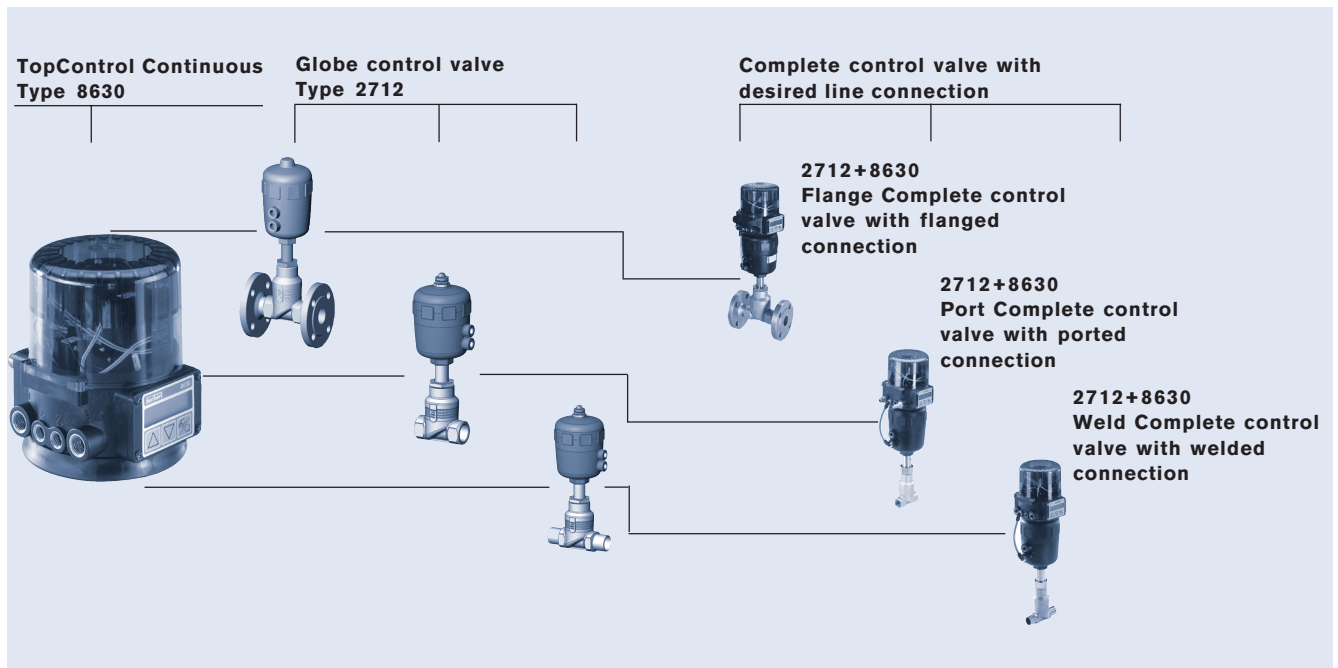

Ordering table for TopControl Continuous Type 8630 without control valve (excerpt, other versions on request)

Function	Inductive proximity switch	Analog feedback	Binary outputs	Binary inputs	Electrical connection (with terminals strip)	Item no. Actuator Ø 80/100 mm	Item no. Actuator Ø 125 mm
Position control	without	without	without	with	cable bushing	140 600	143 429
Position control	without	with	2	with	cable bushing	140 611	144 158
Position and process control	without	without	without	with	cable bushing	140 616	143 410
Position and process control	without	with	2	with	cable bushing	145 909	144 471
Position control	without	without	without	with	circular MP plug	143 141	145 521
Position and process control	without	without	without	with	circular MP plug	142 780	143 393
Position control	2	without	without	with	circular MP plug	142 208	145 522
Position and process control	2	without	without	with	circular MP plug	142 292	143 426
Position control	without	with	2	with	circular MP plug	140 612	145 523
Position and process control	without	with	2	with	circular MP plug	140 626	144 139
Position control with PROFIBUS DP	without	without	without	without	circular MP plug	157 781	158 769
Position control with DeviceNet	without	without	without	without	circular MP plug	145 526	145 527

DTS 1000010797 EN Version: C Status: RL (released | freigegeben | valide) printed: 30.06.2006

## Ordering chart for accessories

Designation	Item no.	Designation	Item no.
M16 socket, 12-pole, position/process setpoint; binary input and binary outputs	917 675	M8 plug, 4-pole, initiators	917 131
		M12 plug, inverse coding, PROFIBUS DP	918 198
M12 socket, 4-pole, voltage supply	917 116	M12 socket, 5-pole, DeviceNet	917 116
M8 socket, 4-pole, process value	917 676	M12 socket, inverse coding, PROFIBUS DP	918 447

To find your nearest Burkert facility, click on the orange box →

[www.burkert.com](http://www.burkert.com)If case of special conditions,  
please consult for advice.We reserve the right to make  
technical changes without notice.

12\_2004\_A\_00891890