

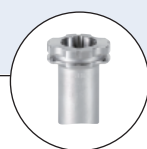

Type 8045 can be combined with...



Type S020
INSERTION
T-fitting



Type S020
Spigot



Type 2030
Diaphragm valve



Type 2712
Globe control valve
with TopControl

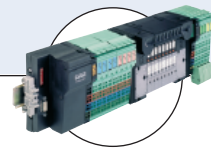

Type 8644
Valve islands with
electronic I/O

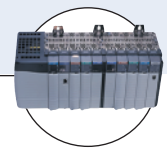

PLC

Electromagnetic Flow Transmitter

- Sensor in solid state technology
- Shows both flow rate and volume
- Simulation: all output signals provided without the need for real flow
- Clean in place (CIP), FDA approved
- Version with Alloy C22 electrodes

The electromagnetic flow meter Type 8045 has been designed for pipes with diameters ranging from DN 06 to DN 400 and liquids having a conductivity > 20 µS/cm.

The transmitter has a display, a keyboard and provides 4-20 mA, relay and pulse outputs;

The version with a stainless steel sensor has been designed for applications with high pressures (PN16) and high temperatures (up to 110°C).

The version with Alloy C22 electrodes has been designed for applications with aggressive fluids (chemicals) and especially sea water applications.

¹⁾ Under reference conditions i.e. measuring fluid=water, ambient and water temperature=20°C (68°F), applying the minimum inlet and outlet pipe straights, matched inside pipe dimensions.

* F.S.= of Full scale (10 m/s)

Technical data

General data

Compatibility	with fittings S020 (see corresponding data sheet)
Materials	
Housing, cover, nut	PC (glass fibre reinforced for housing)
PVDF sensor version	PPA (glass fibre reinforced)
St.St. sensor version	Polyester
Front panel foil	PSU
Protection lid	Stainless steel / EPDM / PA
Screws / Seal / Cable glands	
Wetted parts materials	
Sensor armature	PVDF or Stainless steel 1.4404/316L
Electrodes	Stainless steel 1.4404/316L or Alloy C22
Gaskets	FKM (FDA agreements)
Earth ring (PVDF sensor version)	Stainless steel 1.4404/316L or Alloy C22
Electrode holder (St.St. sensor version)	PEEK (FDA agreements)
Electrical connections	Cable glands M20 x 1.5 (for max. 1.5 mm ² cross-section, shielded)

Complete device data (Fitting S020 + transmitter)

Pipe diameter	DN 06 to 400
Measuring range	0.2 to 10 m/s
Sensor element	Electrodes
Fluid temperature	
PVDF sensor version	0 up to 80°C (32 to 176°F) (depends on fitting)
St.St. sensor version	-15 up to 110°C (5 to 230°F) (depends on fitting)
Fluid pressure max.	see pressure/temperature diagram
PVDF sensor version	PN10 (145.1 PSI)
St.St. sensor version	PN10 (145.1 PSI) (with plastic fitting) - PN16 (232.16 PSI) (with metal fitting)
Conductivity	min. 20 µS/cm
Accuracy	(for measured value from 1 to 10 m/s)
Teach-In	≤ ±2% of Reading ¹⁾
Standard K-factor	≤ ±4% of Reading ¹⁾
Linearity	≤ ±(1% of Reading + 0.1% of F.S.* ¹⁾
Repeatability	≤ 0.25% of Reading ¹⁾

Electrical data	
Power supply	18-36 V DC filtered and regulated (3 wires)
Reversed polarity of DC	protected
Current consumption	≤ 300 mA
Output	NPN and PNP, open collector, galvanic insulation, max. 250 Hz, up to 36 V DC, 100 mA max., protected against short-circuits and polarity reversals. 2 normally open relays, freely adjustable, 250 V AC, 3 A or 30 V DC, 3 A (resistive load), max. cutting power of 750 VA (resistive load); Hysteresis thresholds. Relay 2 programmable for a flow direction detection 4-20 mA, max. loop impedance: 1300 Ω at 30 V DC, 1000 Ω at 24 V DC, 700 Ω at 18 V DC
Pulse	
Relay (programmable) (option)	
Process value	

Environment	
Ambient temperature	-10 up to +60°C (14 to 140°F) (operating) -20 up to +60°C (-4 to 140°F) (storage)
Relative humidity	< 80%, without condensation
Altitude max. for operating	2000 m

Standards, directives and approvals	
Protection class	IP65
Standards and directives	EN 50081-1, EN 50081-2 EN 61010-1
EMC	
Low voltage	
Pressure	Complying with article 3 of §3 from 97/23/CE directive.*
Vibration	EN 60068-2-6
Shock	EN 60068-2-27
Approvals	FDA

* For the 97/23/CE pressure directive, the device can only be used under following conditions (depend on max. pressure, pipe diameter and fluid).

Type of fluid	Conditions
Fluid group 1, §1.3.a	Forbidden
Fluid group 2, §1.3.a	DN ≤ 32, or DN > 32 and PN*DN ≤ 1000
Fluid group 1, §1.3.b	PN*DN ≤ 2000
Fluid group 2, §1.3.b	DN ≤ 200 or DN ≤ 10 or PN*DN ≤ 5000

Pressure / Temperature diagram

Please be aware of the fluid pressure-temperature dependence according to the respective fitting+transmitter material as shown in the diagrams.

8045 with a PVDF sensor

(depending on the fitting material)

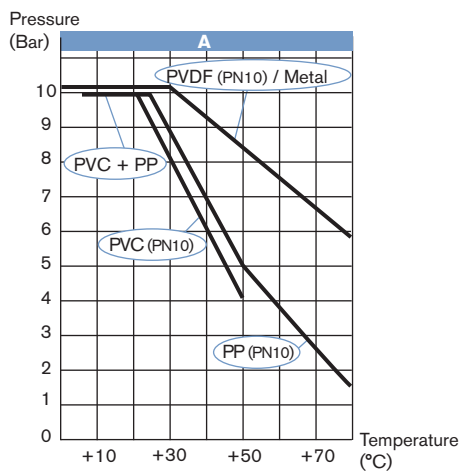

8045 with a stainless steel sensor

(depending on the fitting material)

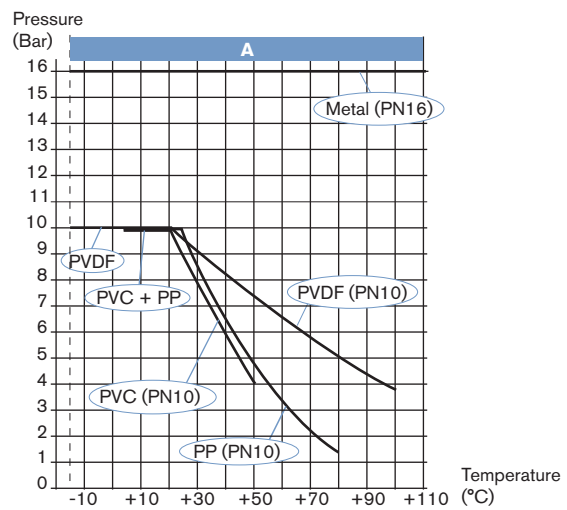

A: Application range for complete device (fitting + transmitter)

Software main features

- International measuring units
- Choice of the display language
- Teach-In for a better accuracy, or K-factor
- 4-20 mA current output
- Pulse output
- 2 relays (option)
- Detection of flow direction possible with the relay 2
- Filter function
- Reset of the main totalizer
- Simulation mode to adjust Zero and Span and simulate flow in dry-run condition

Possible applications

Flow control of fluids, contaminated or not:

- ▶ Waste water treatment
- ▶ Flow control of drinking water (FDA approval)
- ▶ Laundries: measurement and control of the water consumption
- ▶ Swimming pools: pump protection and flow control
- ▶ Food-processing industry: monitoring of the cleaning cycles (FDA approval)
- ▶ Irrigation
- ▶ Application with sea water: desalination, fish farms

Design

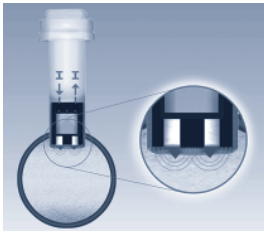

The E-shaped magnetic system inside the sensor induces a magnetic field into the fluid, which is perpendicular to the direction of flow. Two electrodes are in galvanic contact with the liquid. Based on the Faraday law a voltage can be measured between these electrodes once a liquid (min. conductivity of 20 $\mu\text{S}/\text{cm}$) flows along the pipe.

This voltage is proportional to the flow velocity.

Using the K-factor for the individual pipe diameter the speed of flow is converted into volume per time.

Display

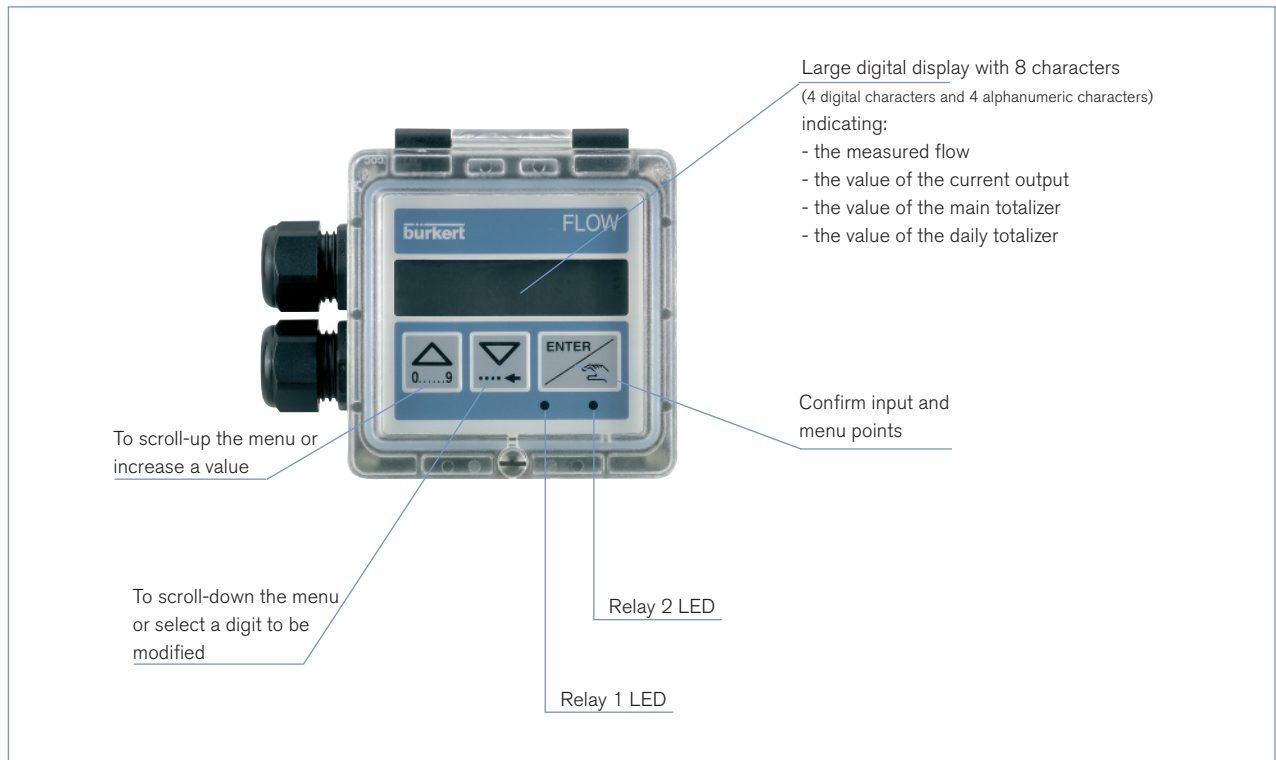

Installation

The 8045 transmitter can easily be installed into any Bürkert INSERTION fitting system (S020) by just fixing the main nut. Minimum straight upstream and downstream distances must be observed. According to the pipe's design, necessary distances can be bigger or use a flow conditioner to obtain the best accuracy. For more information, please refer to EN ISO 5167-1. EN ISO 5167-1 prescribes the straight inlet and outlet distances that must be complied with when installing fittings in pipe lines in order to achieve calm flow conditions. The most important layouts that could lead to turbulence in the flow are shown below, together with the associated prescribed minimum inlet and outlet distances. These ensure calm, problem-free measurement conditions at the measurement point.

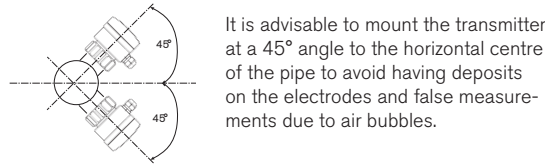
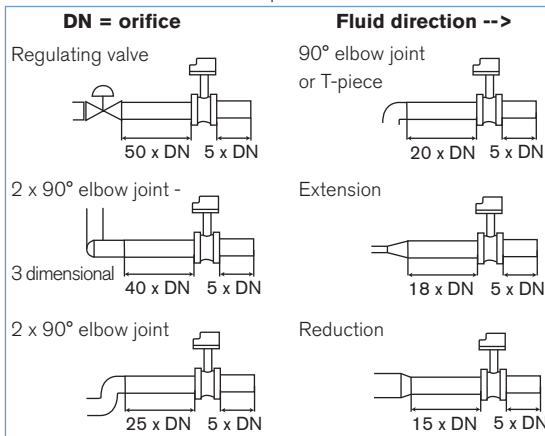

The flow rate transmitter can be installed into either horizontal or vertical pipes. Mount the 8045 transmitter in these correct ways to obtain an accurate flow measurement.

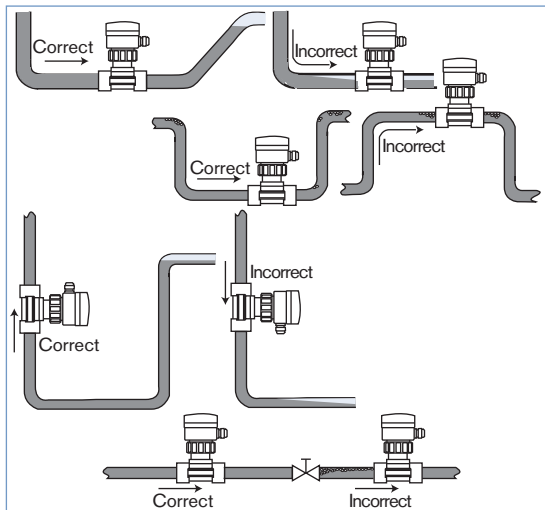

Pressure and temperature ratings must be respected according to the selected fitting material.

The suitable pipe size is selected using the diagram Flow / Velocity / DN.

The flow transmitter is not designed for gas flow measurement.

Selection of fitting / pipe size

Example:

- Specification of nominal flow: 10 m³/h
- Ideal flow velocity: 2..3 m/s
- For these specifications, the diagram indicates a pipe size of DN40 [or DN50 for (*) mentioned fittings]

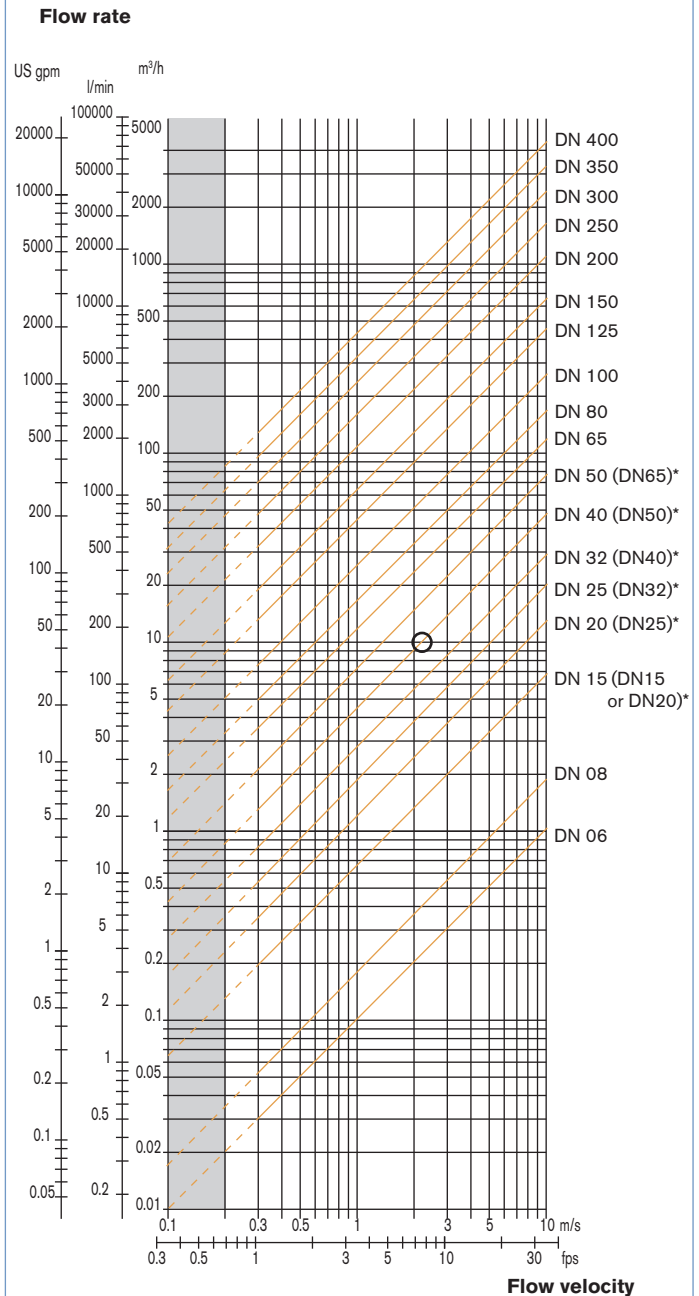

- * for following fittings:
- with external threads acc. to SMS 1145
 - with weld-ends acc. to SMS 3008, BS 4825 / ASME BPE or DIN 11850 Series 2
 - Clamp acc. to SMS 3017 / ISO 2852, BS 4825 / ASME BPE or DIN 32676

Dimensions [mm]

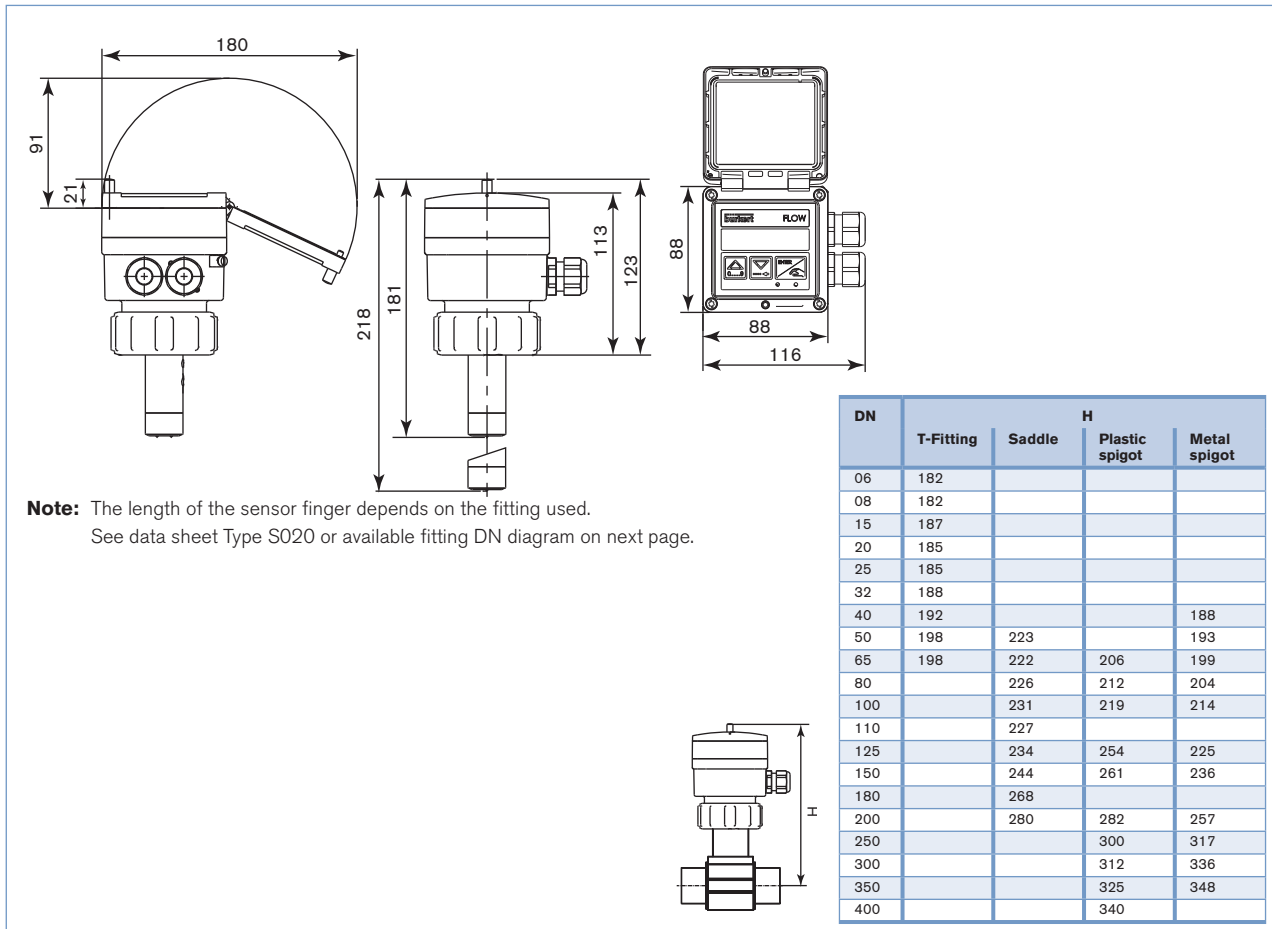

Ordering chart for transmitter Type 8045 - for fitting S020 (see corresp. data sheet)

Voltage supply	Output	Relays	Housing material	Gaskets	Sensor version	Electrode material	Electrical connection	Item no.
18-36 V DC	4-20 mA, pulse	No	PC	FKM	Short, PVDF	Stainless steel	2 cable glands M20 x 1.5	426 498
					Long, PVDF	Stainless steel	2 cable glands M20 x 1.5	426 499
		2	PC	FKM	Short, PVDF	Stainless steel	2 cable glands M20 x 1.5	426 506
					Long, PVDF	Stainless steel	2 cable glands M20 x 1.5	426 507
		No	PPA	FKM	Short, st. steel (FDA)	Stainless steel	2 cable glands M20 x 1.5	449 670
					Long, st. steel (FDA)	Stainless steel	2 cable glands M20 x 1.5	449 672
	2	PPA	FKM	Short, st. steel (FDA)	Stainless steel	2 cable glands M20 x 1.5	449 671	
				Long, st. steel (FDA)	Stainless steel	2 cable glands M20 x 1.5	449 673	
	No	PC	FKM	Short, PVDF	Alloy C22	2 cable glands M20 x 1.5	558 675	
				Long, PVDF	Alloy C22	2 cable glands M20 x 1.5	558 676	

Note: 1 Kit 558 102 and 1 EPDM gasket are supplied with each transmitter.

Ordering chart - accessories for transmitter Type 8045 (has to be ordered separately)

Specifications	Item no.
Set with 2 cable glands M20 x 1.5 + 2 neoprene flat seals for cable gland or plug + 2 screw-plugs M20 x 1.5 + 2 multiway seals 2 x 6 mm	449 755
Set with 2 reductions M20 x 1.5 /NPT1/2" + 2 neoprene flat seals for cable gland or plug + 2 screw-plugs M20 x 1.5	551 782
Set with 1 stopper for unused cable gland M20 x 1.5 + 1 multiway seal 2 x 6 mm for cable gland + 1 green FKM gasket for the sensor + 1 mounting instruction sheet	558 102
Ring	619 205
PC union nut	619 204
PPA union nut	440 229
Set with 1 green FKM + 1 black EPDM gasket	552 111
3 points calibration certificate (device combined with a S020 fitting, only for DN ≤ 200)	550 676
FDA - Approval (only stainless steel sensor version)	449 788

Interconnection possibilities with other Bürkert flow sensors

Type 2731 -
valve with
Type 1067 positioner SideControl
4-20 mA current output

Type 5281 -
Solenoid valve
Relay output

Type 6212 -
Solenoid valve
Relay output

Type 8045 -
Electromagnetic flow transmitter

Type S020 -
Insertion fitting
(see corresp. data sheet)

Available S020 Fitting DN	DN 06	DN65
	T-fitting S020	(1)
Welding tab S020		DN50 Short sensor DN200 Long sensor DN350
Fusion spigot S020		DN65 Short sensor DN100 Long sensor DN400
Screw-on S020		DN100 Long sensor DN400
Saddle S020		DN50 Long sensor DN200

(1) DN 06 and DN 08 in stainless steel S020 only, 8045 with stainless steel sensor recommended

To find your nearest Bürkert facility, click on the orange box →

www.burkert.com

In case of special application conditions, please consult for advice.

Subject to alteration.
© Christian Bürkert GmbH & Co. KG

1010/13_EU-en_00891790