

## 3/2-way Seat Valve, for media up to +180°C, DN13-50



- Ultra compact version
- Long service life
- Valve body in gunmetal
- Various fluidic circuit and actuator control functions

Type 2002 can be combined with...



**Type 6012/6014 P**  
Pilot valve



**Type 8631**  
TopControl On/Off

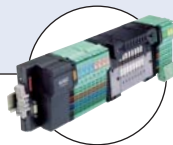

**Type 8640/8644**  
Valve block



**Type 5470**  
Solenoid valve

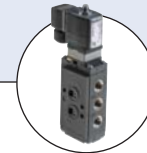

**Type 6519 NAMUR**

The pneumatically operated 3/2-way valve is operated with a piston actuator. The standard actuator material is PA. For high ambient temperatures (eg external sterilization) PPS is available on request for temperatures up to 140°. High flow rates are attained with the gunmetal 3-way body. The reliable self-adjusting packing gland provides high sealing integrity.

Various fluidic circuit functions can be obtained by a simple exchange of the pressure and service ports.

These maintenance-free and robust valves can be retro-fitted with a comprehensive range of accessories for position indication or manual override.

■ **Note:** For PA actuators in the sizes 50 and 63, the combination of max. media temperature and max. ambient temperature is as shown in the following chart:

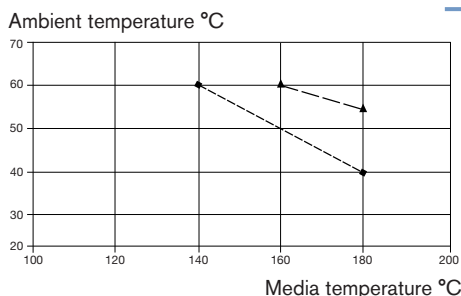

Technical data	
<b>Orifice</b>	DN 13 - 50
<b>Body materials</b>	Gunmetal
<b>Actuator material</b>	PA (PPS on request)
<b>Seal material</b>	PTFE
<b>Media</b>	Water, alcohol, oils, fuels, hydraulic fluid, alkaline solutions, salt solution, organic solutions, hot water, steam
<b>Viscosity</b>	Max. 600 mm <sup>2</sup> /s
<b>Packing gland</b> (with silicone grease)	PTFE V-rings with spring compensation
<b>Media temperature ■</b>	-10 to +180°C
<b>Ambient temperature</b>	
<b>PA actuator ■</b>	-10 to +60°C
<b>PPS actuator</b>	
Actuator sizes Ø 50-80	+5 to +140°C
Actuator sizes Ø 100-125	+5 to +90°C, (up to 140°C for a short period)
<b>Installation</b>	As required, preferably with actuator in upright position
<b>Control medium</b>	Neutral gases, air
<b>Max. pilot pressure</b>	10 bar 7 bar with actuator Ø 125
<b>Port connections</b>	Threaded port ISO228

Ordering chart for valves with port 1 closed by spring action (other versions on request)

Control function	Port connection	Orifice [mm]	Actuator size Ø [mm]	Kv value water [m³/h]		Min. pilot pressure [bar]	Max. operating pressure to 180°C [bar]		Weight	Item no. PA actuator
				1 → 2	2 → 3		1 → 2	2 → 3 2 → 1		
A 3/2-way, normally closed (NC) (port 1)	G 1/2	13	50	7	4.5	4.4	11	16	1.3	002 131
			63	9	5.5	4.7	16	16	1.6	002 300
	G 3/4	20	50	8.9	6.3	4.4	11	16	1.3	002 132
			63	10.5	6.5	4.7	16	16	1.6	002 301
	G 1	25	63	17	11	4.9	10	16	2.1	002 133
			125	38	24	3.4	14	16	8.1	002 302
	G 1 1/4	32	80	32	22	6.0	9	16	4.3	002 134
			125	40	26	3.4	14	16	8.1	002 303
	G 1 1/2	40	80	34	24	6.0	9	16	4.3	002 135
			125	40	26	3.4	14	16	8.1	002 303
	G 2	50	125	55	37	4.3	10	16	9.5	002 136

**i Further versions on request**

**Materials**  
Actuator in PPS

**Approvals**  
GL

**Control functions**  
Normally open (B), Double-acting (I)

Pilot pressure chart (CFA, flow direction 3 → 2)

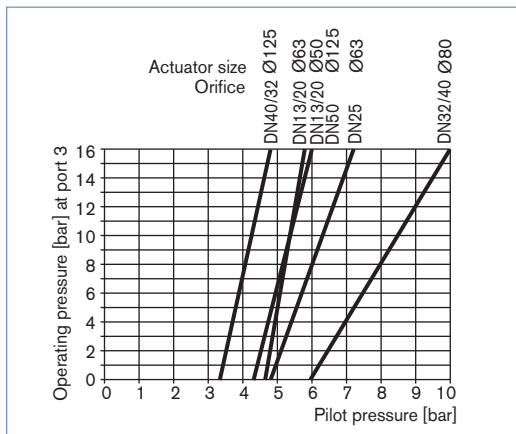

Ordering chart for accessories

3/2-way pilot valves with banjo bolts

Seal material valve FKM, seal material banjo bolt NBR

Valve for actuator size [Ø mm]	Type	Pressure inlet P (valve body)	Service port A (banjo bolt)	Orifice [mm]	Qn value air [l/min]	Pressure range [bar]	Electrical coil connection Ind. Std.	Power consumption [W]	Item no. Voltage/frequency [V/Hz]	
									024/DC	230/50
50-63	6012P	Tube fitting ø6 mm	G 1/4	1.2	48	0-10	Form B	4	552 283	552 286
50-125	6014P	G 1/4	G 1/4	2	120	0-10	Form A	8	424 103	424 107

Cable plug Type 2507, Form B or Type 2508, Form A

	Item no.
Type 2507, Form B Industrial standard, 0 to 250 V without circuitry (Type 6012 P)	423 845
Type 2508, Form A acc. DIN EN 175301-803, 0 to 250 V without circuitry (Type 6014 P, Type 0331P)	008 376

For further accessories see Type 1062, page 238 or the accessories datasheet Type 2XXX for the full options programme.

**Note:** For design reasons, some of the accessories cannot be supplied for actuator size Ø 40 mm. Please request the accessories datasheet Type 2XXX.

## Materials

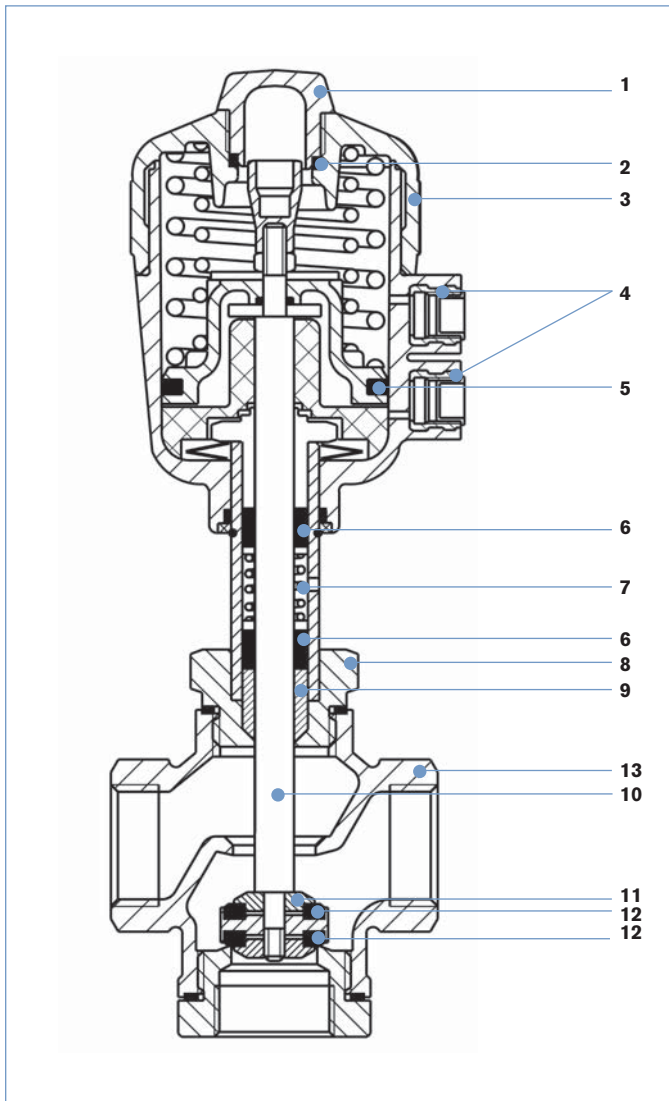

Description	Material
1 Transparent cap	Polycarbonate (PC)
2 O-Ring	FKM
3 Actuator	Polyamide (PA)
4 Pilot air ports G 1/4	Brass
5 Cylinder seal	NBR
6 V-seals	PTFE
7 Tension spring	1.4310
8 Nipple	Brass CuZn
9 Wiper	PTFE
10 Spindle	1.4401
11 Plug	CuZn36Pb1.5
12 Seals	PTFE
13 Valve body	Gunmetal G-CuSn5ZnPb2%Ni

**Connections for fluidic circuit functions C, D, E and F**

Actuator with control function A  
When de-energised port connection 1 is closed with spring

Fluidic circuit function	Connection - port		
	1	2	3
C	P	A	R
D	R	A	P
E	P1	A	P2
F	A	P	B

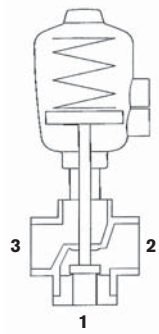

A, B service ports  
P, P1, P2 pressure ports  
R exhaust port

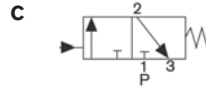

When de-energised, pressure port 1 closed, service port 2 exhausted

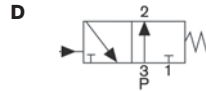

When de-energised, pressure port 3 connected to service port 2, exhaust port 1 closed

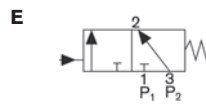

Mixer valve  
When de-energised, pressure port 3 connected to service port 2, pressure port 1 closed

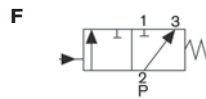

Distributor valve  
When de-energised, pressure port 2 connected to service port 3, service port 1 closed

**Dimensions [mm]**

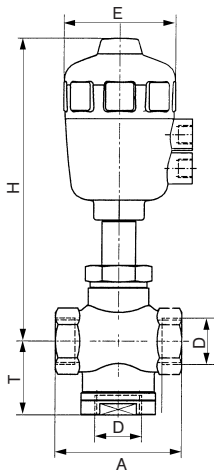

Orifice	Actuator size Ø	Port connection D	A	E	H	T
13	50	G 1/2	75	64	179	49
	63	G 1/2	75	80	213	49
20	50	G 3/4	75	64	179	49
25	63	G 1	90	80	216	52.5
32	80	G 1 1/4	120	101	237	66
	125	G 1 1/4	120	153	336	66
40	80	G 1 1/2	120	101	237	66
	125	G 1 1/2	120	153	336	66
50	125	G 2	160	153	350	85

To find your nearest Bürkert facility, click on the orange box →

[www.burkert.com](http://www.burkert.com)

In case of special application conditions, please consult for advice.

We reserve the right to make technical changes without notice.

1003/4\_EU-en\_00891664