

## 2/2-way Solenoid Valve with servo-diaphragm, G 1/2 - G 2 1/2



Type 5281 can be combined with...



**Type 2508**  
Cable plug



**Type 1078**  
Timer unit



**Type 2511**  
ASI cable plug

- Universal version up to 16 bar
- NBR, EPDM or FKM servo-diaphragms
- Anti-waterhammer, low noise
- NC or NO circuit function
- Brass body or grey cast iron
- Threaded port or flange connections

Servo-assisted solenoid valve with servo-diaphragm for the control of liquid or gaseous media. A pressure difference of 0.5 bar is required for a complete switchover.

Power consumption		
Inrush	Hold (hot coil)	
AC [VA]	AC [VA/W]	DC [W]
24	14/8	8

Technical data	
<b>Orifice</b>	DN 13 - 65 mm
<b>Body material</b>	Threaded port Flange
	Brass acc. to DIN EN 50930-6 Grey cast iron
<b>Insulation class</b>	
<b>Seal material version</b>	
NBR	B
EPDM	H
FKM	H
<b>Inner part valve</b>	Stainless steel, brass
<b>Seal material</b>	NBR, EPDM, FKM
<b>Media</b>	
NBR	Neutral media, such as compressed air, water
EPDM	Oil and fat-free media
FKM	Hot air, per-solutions
<b>Media temperature</b>	
NBR	-10 to +80 °C
EPDM	-40 to +120 °C
FKM	-10 to +120 °C
<b>Ambient temperature</b>	Max. +55 °C
<b>Voltage tolerance</b>	±10 %
<b>Duty cycle</b>	Continuous operation 100% ED
<b>Electrical connection</b>	Tag connector acc. to DIN EN 175301-803 Form A (previously DIN 43650) for cable plug type 2508 (see Ordering chart for accessory on p. 4)
<b>Protection class</b>	IP 65 with cable plug
<b>Installation</b>	As required, preferably with actuator upright
<b>Response times<sup>1)</sup></b>	0.1 - 4 seconds (depending on orifice and differential pressure)

1) Measured at valve outlet at 6 bar and +20°C. *Opening*: pressure build-up 0 to 90%, *Closing*: pressure relief 100 to 10%

## Materials

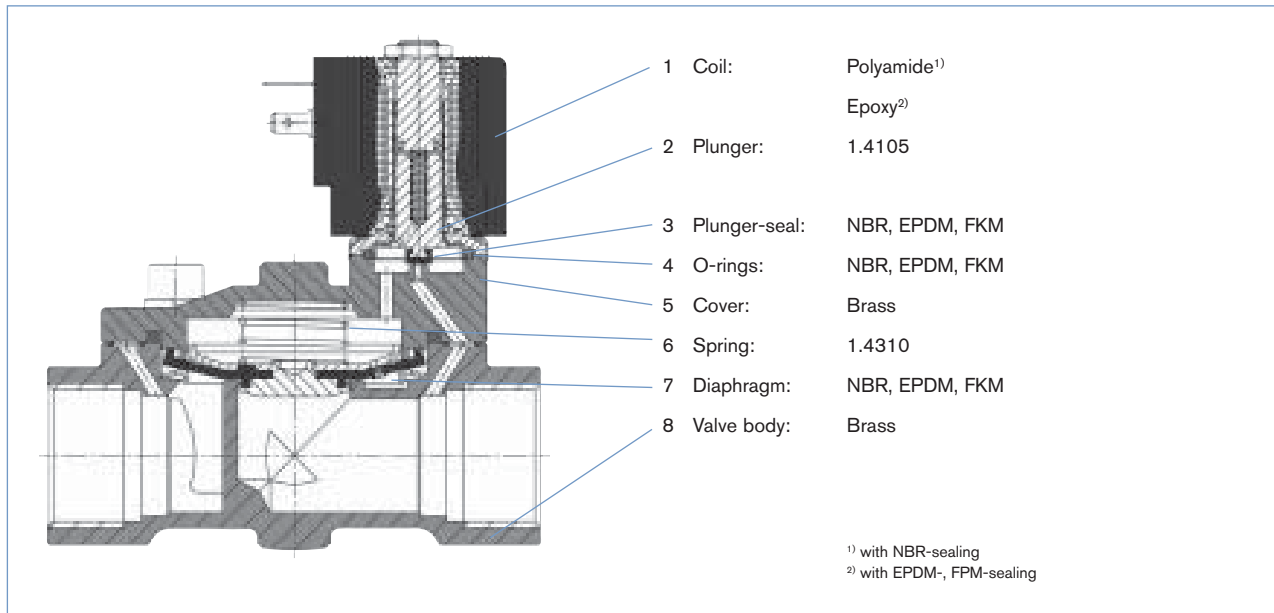

## Ordering chart for valves (other versions on requests)

## Threaded port, brass body, without cable plug

Circuit function	Port connection	Orifice [mm]	Kv value water [m <sup>3</sup> /h]	Pressure range [bar]	Item no. per voltage/frequency [V/Hz]		
					024/DC	024/50-60	230/50-60
<b>A 2/2-way valve NC</b> 	<b>Seal material NBR</b>						
	G 1/2	13	4.0	0.2-16	134 317	134 318	134 320
	G 3/4	20	6.4	0.2-16	134 321	134 322	134 324
	G 1	25	10.0	0.2-16	134 325	134 326	134 328
	G 1 1/4	32	20.0	0.2-16	134 329	134 330	134 332
	G 1 1/2	40	20.0	0.2-16	134 333	134 334	134 336
	G 2	50	40.0	0.2-16	134 337	134 338	134 340
	G 2 1/2	65	40.0	0.2-16	134 341	134 342	134 344
	<b>Seal material FKM</b>						
	G 1/2	13	4.0	0.2-16	134 345	134 346	134 348
	G 3/4	20	6.4	0.2-16	134 349	134 350	134 352
	G 1	25	10.0	0.2-16	134 353	134 354	134 356
	G 1 1/4	32	20.0	0.2-16	134 357	134 358	134 360
	G 1 1/2	40	20.0	0.2-16	134 361	134 362	134 364
	G 2	50	40.0	0.2-16	134 365	134 366	134 368
	G 2 1/2	65	40.0	0.2-16	134 369	134 370	134 372
	<b>Seal material EPDM</b>						
	G 1/2	13	4.0	0.2-16	134 373	134 374	134 376
	G 3/4	20	6.4	0.2-16	134 377	134 378	134 380
	G 1	25	10.0	0.2-16	134 381	134 382	134 384
	G 1 1/4	32	20.0	0.2-16	134 385	134 386	134 388
	G 1 1/2	40	20.0	0.2-16	134 389	134 390	134 392
	G 2	50	40.0	0.2-16	134 393	134 394	134 396
	G 2 1/2	65	40.0	0.2-16	134 397	134 398	134 400

## Ordering chart for valves (other versions on requests), cont.

## Threaded port, brass body, without cable plug

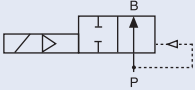
Circuit function	Port connection	Orifice [mm]	Kv value water [m <sup>3</sup> /h]	Pressure range [bar]	Item no. per voltage/frequency [V/Hz]		
					024/DC	024/50	230/50
<b>B</b> 2/2-way valve NO 	<b>Seal material NBR</b>						
	G 1/2	13	4.0	0.2-16	178 873	178 872	178 874
	G 3/4	20	6.4	0.2-16	178 876	178 875	178 877
	G 1	25	10.0	0.2-16	178 879	178 878	178 881
	G 1 1/4	32	20.0	0.2-16	178 883	178 882	178 884
	G 1 1/2	40	20.0	0.2-16	178 886	178 885	178 887
	G 2	50	40.0	0.2-16	178 889	178 888	178 891

Circuit function B: Total height "B1" 2 mm higher than for circuit function A

**Please note** that the cable plug has to be ordered separately, see Ordering chart for accessory on last page or separate datasheet for Type 2508

## Threaded port, brass body and manual override, without cable plug

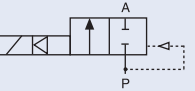
Circuit function	Port connection	Orifice [mm]	Kv value water [m <sup>3</sup> /h]	Pressure range [bar]	Item no. per voltage/frequency [V/Hz]		
					024/DC	024/50-60	230/50-60
<b>A</b> 2/2-way valve NC 	<b>Seal material NBR</b>						
	G 1/2	13	4.0	0.2-16	139 307	139 308	138 314
	G 3/4	20	6.4	0.2-16	139 309	139 310	139 311
	G 1	25	10.0	0.2-16	139 312	139 313	138 801
	G 1 1/4	32	20.0	0.2-16	139 314	139 315	139 316
	G 1 1/2	40	20.0	0.2-16	139 317	139 318	139 319
	G 2	50	40.0	0.2-16	139 320	139 321	139 322
	G 2 1/2	65	40.0	0.2-16	139 323	139 324	139 325

## Flange acc. to DIN 2501, grey cast iron flange body, without cable plug

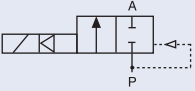
Circuit function	Port connection	Orifice [mm]	Kv value water [m <sup>3</sup> /h]	Pressure range [bar]	Item no. per voltage/frequency [V/Hz]		
					024/DC	024/50-60	230/50-60
<b>A</b> 2/2-way valve NC 	<b>Seal material NBR</b>						
	Flange acc. DIN 2501	25	10.0	0.2-16	134 401	134 402	134 404
		32	20.0	0.2-16	134 405	134 406	134 408
		40	20.0	0.2-16	134 409	134 410	134 412
		50	40.0	0.2-16	134 413	134 414	134 416

## Dimensions [mm]

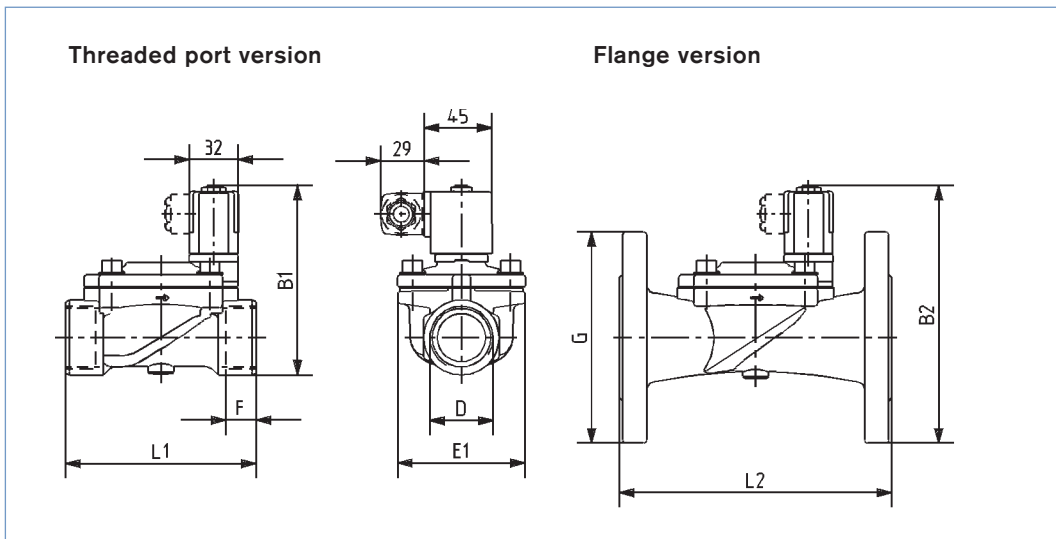

DN	D	Threaded port						Flange			
		B1 Circuit function A	B1 Circuit function B	B1*	E1	F	L1	B2	B2*	G	L2
13	G 1/2	100.0	102.0	110	40	14	65	-	-	-	-
20	G 3/4	107.5	109.5	117.5	60	16	100	-	-	-	-
25	G 1	116.0	118.0	126.0	70	18	115	159.5	169.5	120	160
32	G 1 1/4	126.5	128.5	136.5	85	20	126	171.5	181.5	140	180
40	G 1 1/2	135.5	137.5	145.5	85	22	126	180.5	190.5	150	200
50	G 2	157.2	159.2	167.2	115	24	164	204.7	214.7	165	230
65	G 2 1/2	157.2	159.2	167.2	115	27	180	-	-	-	-

B1\* + B2\* Version with manual override

### i Further versions on request

**Approvals**

UL/UR/CSA, ATEX-Ex, UL-fire protection, European gas approval

**Voltage**

110/50, other non-standard voltages

**Port connection**

NPT, Rc

### Ordering chart for accessory

#### Cable plug Type 2508 according to DIN EN 175301-803 Form A

	Circuitry	Voltage / frequency	Item no.
	None (standard)	0 - 250 V AC/DC	008 376
	further versions see datasheet Type 2508		

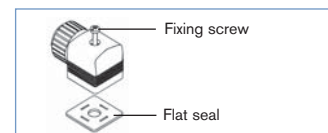

The delivery of a cable plug includes the flat seal and the fixing screw. For other cable plug versions acc. to DIN EN 175301-803 Form A (previously DIN 43650), see separate datasheet Type 2508.

To find your nearest Bürkert facility, click on the orange box →

[www.burkert.com](http://www.burkert.com)

In case of special application conditions,  
please consult for advice.

Subject to alteration  
© Christian Bürkert GmbH & Co. KG

0907/4\_EU-en\_00891710